

iNDESIT

FV1 GB

GB **Electric fan oven**
Instructions for installation and use

10:00

After the time has expired, an acoustical signal will be emitted, which can be turned off by pressing any of the buttons (except the + and - buttons) at this point the  symbol will also turn off.

Correction/Cancellation of Data

- The data entered can be changed at any time by pressing the corresponding button and the + or - buttons.
- When the data for the length of the cooking time is cancelled, the data for the end cooking time are also cancelled automatically, and vice versa.

- If the oven has been programmed, it will not accept end cooking times which are before the start of the cooking process.
- When the  button (manual) is pressed, all data which has been entered will be cancelled.

How to Change the Sound of the Buzzer

Three different sounds can be chosen for the buzzer:

When the - button is pressed and held down for the first time, the sound which is heard is the sound selected for the buzzer. By releasing the button and then pressing it again, you can listen to the other sounds for the buzzer and select them.

Routine maintenance and oven cleaning

Before each operation, disconnect the cooker from the electricity. **To assure the long life of the cooker, it must be thoroughly cleaned frequently, keeping in mind that:**

- the oven vents are cleaned with a liquid cleaner after each use. some discolouration may show on white oven handles. This is unavoidable;
- the enamelled parts and the self-cleaning panels are washed with warm water without using any abrasive powders or corrosive substances which could ruin them;
- the inside of the oven should be cleaned fairly often while it is still warm using warm water and detergent, followed by careful rinsing and drying;
- stainless steel may become marked if it comes into contact with very hard water or harsh detergents (containing phosphorous) for long periods of time. After cleaning, it is advisable to rinse thoroughly and dry. It is also recommended to dry any water drops;

N.B: avoid closing the cover while the gas burners and electric plates are still warm.

Important: periodically check the wear of the gas hose and substitute it if there are any defects; we recommended

changing it every year.

Replacing the oven lamp

- Unplug the oven from the mains;
- Remove the glass cover of the lamp-holder;
- Remove the lamp and replace with a lamp resistant to high temperatures (300°C) with the following characteristics:
 - Voltage 240V
 - Wattage 25W
 - Type E14
- Replace the glass over and connect the oven to the mains.

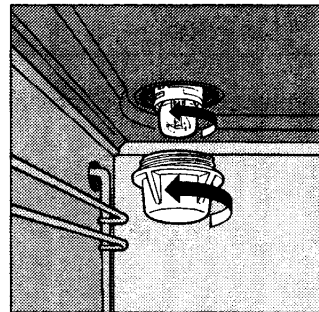

- 1 These instructions are only for those countries whose symbols appear in the booklet and on the matriculation plate of the appliance.
- 2 This appliance is intended for non-professional use within the home.
- 3 This owner's manual is for a class 1 appliance (installed independently) or class 2 - sub-class 1 appliances (installed between two cabinets).
- 4 Before using your appliance, read your owner's manual carefully since it provides important instructions for the safe installation, use and maintenance of your cooker. Keep in a safe place for future reference.
- 5 When you have removed the packing, check that the appliance is not damaged. If you have any doubts, do not use the appliance, contact your nearest Ariston Service Centre. Never leave the packing components (plastic bags, foamed polystyrene, nails, etc.) within the reach of children since they are a source of potential danger.
- 6 The appliance must be installed only by a qualified person in compliance with the instructions provided. The manufacturer declines all responsibility for improper installation which may harm persons and animals and damage property.
- 7 The electrical safety of this appliance can only be guaranteed if the cooker is correctly and efficiently earthed, in compliance with current regulations on electrical safety. Always ensure that the earthing is efficient; if you have any doubts call in a qualified electrician to check the system. The manufacturer declines all responsibility for damage resulting from a system which has not been earthed.
- 8 Before connecting the appliance to the mains, check that the specifications indicated on the rating plate (on the appliance and/or packaging) correspond to those of the electrical mains system of your home.
- 9 The openings and slots used for ventilation and dispersion of heat on the rear and below the control panel must never be covered.
- 10 This appliance must be used for the purpose for which it was expressly designed. Any other use (e.g. heating rooms) is considered to be improper and consequently dangerous. The manufacturer declines all responsibility for damage resulting from improper and irresponsible use.
- 11 A number of fundamental rules must be followed when using electrical appliances. The following are of particular importance:
 - do not touch appliance with wet or damp hands or feet
 - do not use the appliance while bare-footed
 - do not use extension leads other than with the utmost caution
 - do not pull the power supply cable or the appliance itself to disconnect the plug from the socket.
 - do not expose the appliance to weather agents (raining, sun, etc)
 - do not allow unsupervised children or inexperienced persons to use the appliance.
- 12 Always switch off the electrical supply to the cooker and allow it to cool down before carrying out any cleaning operations etc.
- 13 In the case of faults and/or faulty operation, switch off the electricity supply to the cooker and do not tamper with it. For repairs call only an authorised after-sales servicing centre and request the use of original spare parts only. Failure to comply with the above may compromise the safety of the appliance.
- 14 Remember if you are discarding any domestic appliance with which children etc. may play, make it safe by removing the Mains Cable from it, after first disconnecting the electricity supply. Remove glass parts where possible, and consider sharp edges etc. which may now be exposed.
- 15 Oven gloves or similar protection should be used when moving containers in or out of hot ovens and care should be taken to avoid contact with hot surfaces of exposed skin on wrists or arms.
- 16 One of the commonest types of accident involving cooking appliances is burns to babies and young children. These can occur by:
 - Touching hot parts
 - Being splashed with hot liquids
 - By pulling projecting pan handles and tipping hot liquids over themselves
- 17 Please remember that a small child's skin is far more sensitive and therefore more easily burnt than an adult. You are, therefore, strongly advised to keep babies and young children well clear of this appliance during use and whilst it is cooling down after use.
- 18 Never use flammable liquids such as alcohol or gasoline, etc. near the appliance when it is in use.
- 19 Make sure the knobs are in the "•"/"o" position when the appliance is not in use.
- 20 When you are using the grill or the oven, some parts of the door can become very hot. Keep children away from these.
- 21 Unstable or out of shape pans should not be used on the hob in case they cause spillage of hot liquids.
- 22 Pans must only be placed in the centre of electric rings and of grids on gas burners. Placing pans off centre or to one side may cause spillage.
- 23 Special care should be taken when using chip pans etc. in order to avoid splashing or spillage of hot oil. They should not be used unattended since overheated oil may boil over and ignite on the hot heating element or gas flame.
- 24 Some parts of the appliance, in particular the hot plates, remain heated for a long time after use. Make sure not to touch them.

Installation

All instruction on the following pages must be carried out by a competent person (corgi registered) in compliance with gas safety (installation and use) regulation 1984.

Important: disconnect the oven from the electricity when making any adjustment, maintenance operation, etc.

Unpacking

Remove the outer packing from the oven. Open the door outwards and remove packing from the shelves. Take out the plastic envelope containing instruction book, guarantee card and 4 fixing screws.

Installation

To ensure the good working order of a flush-mountable appliance, the kitchen unit must be of a suitable size. In figure you can find the required unit sizes for installing the appliance under a worktop or in a column unit.

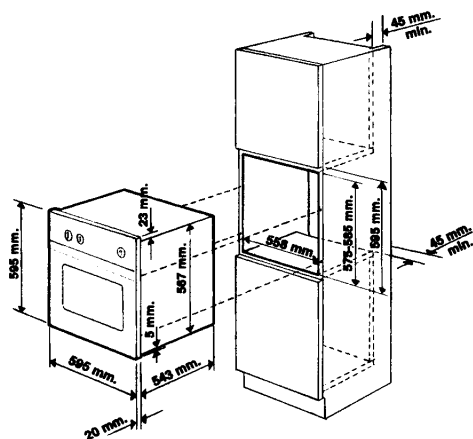
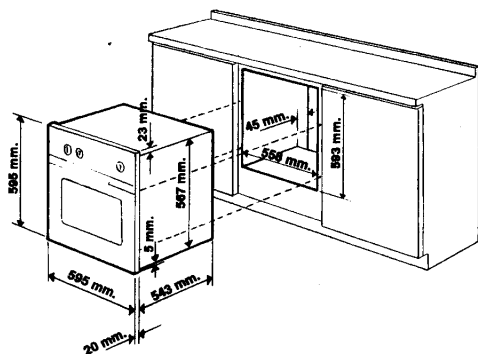

Remove any back panels fitted to the cabinet. When installing undertable ensure there is a space of at least 45 mm between the rear of any shelves or support (excluding the worktop) and the rear wall. When installing vertically ensure there is a space of at least 45 mm between the rear of any shelves, support or cupboards and the rear wall. To fix the oven to the cabinet, open the oven door and insert the 4 wooden screws provided into the holes along the edge of the frame (D). The panels of adjacent furniture should be made of heatproof material and in the case veneered furniture units, the glue used should resist temperatures of up to 100°C. Once the appliance has been installed, the electrical parts must be totally protected from all contact, according to current safety regulations. All protecting parts should be firmly fixed and should

require the use of a tool for removal.

Electrical connection

Ovens with a three-pole power supply cable are designed to operate with alternated current at the supply frequency and voltage indicated on the data plate (at the bottom of the oven dashboard). The earthing conductor of the cable is the yellow-green conductor.

Two types of connection are provided:

Connection n° 1

Connecting the power supply cable to the mains.

Fit a normalized plug to the cable, which corresponds to the load indicated on the data plate; if the cooker is connected directly to the mains, an omnipolar circuit-breaker with a minimum opening of 3 mm between the contacts, suitable for the load indicated and complying with current directives, must be installed between the appliance and the mains (the earthing wire must not be interrupted by the circuit-breaker). The power supply cable must be positioned so that it does not exceed room temperature by 50°C at any point of its length. Before making the connection check that:

- the limiter valve and the home system can support appliance load (see data plate);
- the power supply system has an efficient earthing connection which complies with the provisions of current regulations and the law;
- there is easy access to the socket or the omnipolar circuit-breaker once the cooker has been installed.

N.B.: do not use reducers, adapters or shunts as these could cause heating or burning.

Connection n° 2

Disposing of the plug.

WARNING: THIS APPLIANCE MUST BE EARTHED.

Ensure that before disposing of the plug itself, you make the pins unusable so that it cannot be accidentally inserted into a socket. Instructions for connecting cable to an alternative plug:

Important: the wires in the mains lead are coloured in accordance with the following code:

Green & Yellow	-Earth
Blue	-Neutral
Brown	-Live

If the colours of the wires in the mains lead do not correspond with the coloured markings identifying the terminals in your plug, proceed as follows.

Connect Green & Yellow wire to terminal marked "E" or \equiv or coloured Green or Green & Yellow.

Connect Brown wire to terminal marked "L" or coloured Red. Connect Blue wire to terminal marked "N" or coloured Black. If a 13 amp plug (BS 1363) is used it must be fitted with a 13 amp fuse.

A 15 amp plug must be protected by a 15 amp fuse, either in the plug or adaptor or at the distribution board. If you are in any doubt about the electrical supply to your machine, consult a qualified electrician before use.

How to connect an alternative plug

The wires in this mains lead are coloured in accordance with the following code:

BLUE "NEUTRAL" (N)
BROWN "LIVE" (L)
GREEN AND YELLOW "EARTH" (E)

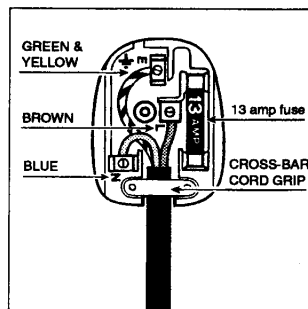

Disposing of the appliance

When disposing of the appliance please remove the plug by cutting the mains cable as close as possible to the plug body and dispose of it as described above.

Technical characteristics

Oven size:	
- width	cm 40
- depth	cm 39
- height	cm 34
Oven size: 53 litres	
Voltage and frequency: 230 - 240V~ 50-60Hz	
Power: 2100 - 2200 W	



This appliance conforms with the following European Economic Community directives:

- 73/23/EEC of 19/02/73 (Low Voltage) and subsequent;
- 89/336/EEC of 03/05/89 (Electromagnetic Compatibility) and subsequent;
- 93/68/EEC of 22/07/93 and subsequent.

The cooker with fan oven

- A Panel
- B Dripping or cooking plate shelf
- C Oven grill shelf
- D Holes for fixing screws
- E Inner glass
- F Screws to fix inner glass
- G Selection knob
- H Thermostat knob
- I Timer clock
- L Thermostat pilot lamp

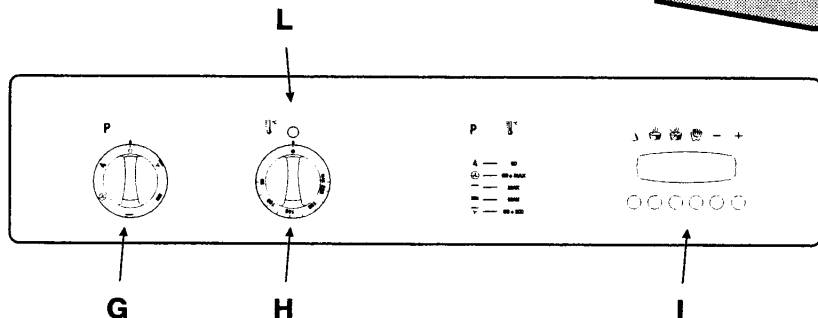
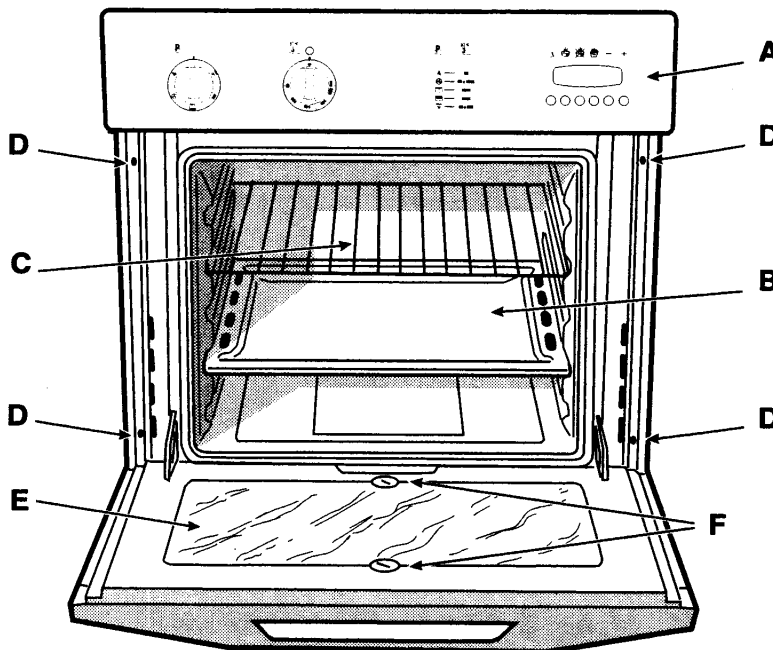

The different functions of the oven and how they may be used

The different functions offered by the oven are selected by operating the controls and devices situated on the oven panel.

The oven knobs (G-H)

With this two controls you can select the different functions of the oven and choose the cooking temperature suitable for the food you are preparing. The different cooking functions are up by operating this two knobs:

the selection knob (G)

the thermostat knob (H)

For any selection-knob setting different from idle, identified by the "0", the oven light turns on; the knob setting marked

 permits turning on the oven light without any heating element being switched on.

1. Thawing

- Knob "G" position: 1

- Knob "H" position: **any position**

A service programme the fan at the back of the oven makes the air circulate around the food at room temperature. This programme may be used for defrosting any type of food and is ideal for delicate foods which can not be heated such as: ice-cream cakes, cream cakes and fruit cakes. Defrosting takes half the time required normally. To defrost meat, fish or bread faster use the fan oven function with the temperature set at 80°-100°C.

2 Fan oven cooking

- Knob "G" position: 2

- Knob "H" position: anywhere between 60°C and **Max**

The oven light turns on; the fan and heating element are also switched on. Reducing preheating time by 40% the fan oven permits energy savings of around 30% during the heating period. Since the heat in the fan oven is constant and uniform throughout the oven, different dishes may be cooked at the same time as long as the cooking times for these are same. To use two grids at the same time follow the instructions indicated in the chapter on "Cooking with different grids at the same time". The fan oven may also be used to defrost white or red meat, fish and bread with the temperature set at 80°-100°C.

3. The grill

- Knob "G" position: 3

- Knob "H" position: **Max**

The oven light turns on and so does the single heating element (inner) and the motor starts turning the spit. The rather high and direct temperature of the grill permits browning the outside of meats immediately thus keeping in the juices and assuring tenderness.

4. The double grill

- Knob "G" position: 4

- Knob "H" position: **Max**

The oven light turns on and so does the double heating element of the grill and the motor starts turning the spit. This grill is larger than the average and has a completely new design: cooking performance is increased 50%.

The double grill makes sure that even the corners are touched by heat.

5. The browning oven

- Knob "G" position: 5

- Knob "H" position: anywhere between 60°C and 200°C

The oven light turns on and the double grill elements switches on with the fan motor. On this setting unidirectional heat radiation is combined with the forced circulation inside the oven. This keep the food surface from burning and increases the penetration power of the heat.

Attention: before using the oven and grill for the first time, turn the oven on for approximately one half hour. Make sure that the oven is empty, the thermostat on high, the door open, and the room properly ventilated. The odor which can be detected at times is due to the evaporation off the substances used to protect the oven and the grill during the period between the and installation of the appliance.

Use of the grill

Grilling may be carried out with a two stage heating element situated in the top of the oven chamber. The centre, or the complete area of the grill can be selected by turning the oven control knob (G) to position 3 for the centre, 4 for the complete area and 5 for the complete area and the fan.

To operate the grill

1. Turn the oven control knob (G) clockwise to the required grilling section.
2. Turn the thermostat knob (H) to MAX. The element is now "on".

When utilizing the grill, place the rack at the lower levels (see cooking table). To catch grease or fat and prevent smoke, place a dripping-pan at the bottom rack level.

Grilling should normally be carried out with the door closed to obtain the best results and save energy (about 10%).

When this recommendation is not possible, a special deflector is supplied, and this must be placed in position to protect the controls from excessive heat. Below the control panel at the door closure point, are two retaining lugs for the deflector, the deflector should be placed in position before grilling commences.

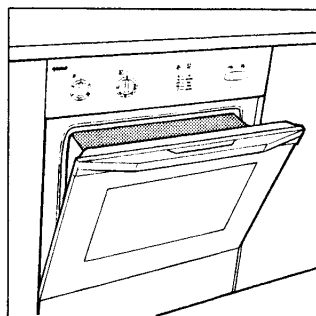

Note: in position 5 the door must be always kept closed to permit good air circulation inside the oven.

Caution:

- When grilling using the heat deflector, the oven door must remain fully open throughout the whole period of grilling.
- The deflector will become extremely hot during grilling. Allow time to cool in position before attempting to

remove.

The thermostat pilot lamp (L)

This lamp is situated to the left of the oven control knob and will glow when the oven is first switched "on", it will extinguish once the correct oven temperature has been reached.

Inner glass oven door (E)

The oven is provided of an inner glass that can be removed unscrewing the two screws (F) that fix it to the door. **This**

glass must be replaced after cleaning and always be in position when cooking.

Oven door





You can buy a special kit to reduce door temperature when the oven is on and save energy. If there are little children in the house, this kit is a must. The kit code number is 039888 and it may be purchased for installation from an authorised dealer or a Technical Assistance Service centre indicated in the list included with the appliance documents.

The electronic cooking programmer

This feature allows you to program the oven or the grill as follows :

- delayed start for a specific length of time;
- immediate start for a specific length of time;
- timer.

Button Functions:

-  : timer - hours and minutes;
-  : cooking time;
-  : end cooking time;
-  : manual change;
- : set cooking time - backward;
- + : set cooking time - forward.

How to reset the digital clock.

After the appliance has been connected to the power supply, or when the power has gone out, the clock display will automatically reset to 0:00 and begin to blink.

- Press the  button and then reset the time (within 4 seconds) using the — and + buttons.

The + button sets the time forward.

The — button sets the time backward.

Whenever the time must be reset, follow this same procedure.

Manual Operation of the Oven

After resetting the time, the program automatically switches to the manual mode (the  will be displayed).

 0:00
manual

 0:00
automatic

In all other situations, press the  button.

How to Program the Oven

The length of the cooking program as well as the time at which the cooking program ends must be set. If we assume that the time displayed on the timer is 10:00:

- 1 Turn the oven control knobs to the feature and temperature desired (e.g. conventional oven, 200°C);
- 2 Press the  button and then set the cooking time (within four seconds) using the — and + buttons. Let us suppose that we set the cooking time at 30 minutes. The display will read as follows:

 0:30

After the button has been released, the current time will be displayed again after approximately 4 seconds, along with

the  symbol and the word **auto**;



- 3 Press the  button and then use the — and + buttons to set the time for when the cooking program should end. Let us suppose this time to be 1:00 p.m.

 13:00

- 4 After the button has been released, the current time will be displayed after approximately 4 seconds:

 10:00

The word **auto** will light up reminding you that the length and end cooking time were programmed in automatic mode. At this point, the oven will turn on automatically at 12:30 and then turn off after 30 minutes. When the oven is

turned on, the  symbol will be displayed for the entire cooking time. At any time during the cooking process, the length of the cooking time can be displayed by pressing the  button, and the end cooking time by pressing the  button.

After the cooking time has expired, the timer will ring for several minutes; to turn it off, simply press any of the buttons except the — and + buttons.

If only the length (point 2) of the cooking time has been programmed, the oven will turn on immediately.

Timer Feature

The timer feature allows you to enter a given amount of time from which the timer begins to count down. This feature does not turn the oven on or off; it merely sounds when the time has expired.

When the  button has been pressed, the display will read as follows:

0:00

Then use the + and — buttons to set the desired time. After the button has been released, the timer will start to count down and the current time will be displayed.

Practical advice for oven cooking

Selection knob setting (G)	Food to be cooked	Wt. (Kg)	Cooking position from bottom	Heating time (min.)	Thermostat knob (H)	Cooking time (min.)
1 Thawing	All frozen foods					
2 Ventilated	Lasagne	2.5	2	-	180	65 - 70
	Cannelloni	2.5	2	-	180	65 - 70
	Baked noodles	2.5	2	-	180	65 - 70
	Veal	1.7	2	-	180	75 - 80
	Chicken	2.1	2	-	160	140 - 145
	Turkey	3	2	-	180	85 - 90
	Duck	1.8	2	-	160	120 - 125
	Rabbit	2	2	-	160	95 - 100
	Pork	2.1	2	-	160	95 - 100
	Lamb	1.8	2	-	160	85 - 90
	Mackerel	1.1	2	-	160	50 - 55
	Red porgy	1.5	2	-	160	55 - 60
	Trout baked in paper	1	2	-	160	35 - 40
	Napolitan pizza	1	3	-	220	15 - 20
	Flan or tart	1.1	3	-	160	30 - 35
Chocolate cake	1	3	-	160	45 - 50	
3 Grill	Sole and cuttle fish	1	4	5	Max	8
	Squid and shrimp on spits	1	1	5	Max	4
	Cod steaks	1	4	5	Max	10
	Grilled vegetables	1	2	5	Max	8 - 10
4 Double Grill	Veal steaks	1	4	5	Max	15 - 20
	Cutlets	1.5	4	5	Max	25
	Hamburgers	1	3	5	Max	7
5 Double ventilated grill	Grilled chicken	1.5	2	5	Max	55 - 60
	Grilled duck	2	2	5	Max	75 - 90
	Cuttle fish	0.5	2	5	Max	40 - 45

N.B. : the baking times indicated are approximate and may vary according to your personal taste and experience.



Merloni Elettrodomestici spa
viale Aristide Merloni, 47 - 60044 Fabriano
tel. 0732/6611 - telex 560196 - fax 0732/662954
www.Merloni.com

Forno ventilato
02/99 - 195013714.04 Xerox Business Services - Docutech